





Fitting for 2 top-running wooden doors up to 26 kg (57 lbs.), with groove mounted running track. With soft and self closing mechanism. Design Inside.

Product highlights

-  **Flexibility** Wide range of applications for sliding door cabinets in any dimension
-  **Productivity** Easy installation with tool-less clip-on system and convenient height adjustment

Technical specifications

-  Max. 26 kg (57 lbs.)
-  Max. 2200 mm (7'2 5/8")
-  Max. 1000 mm (3'3 3/8")
-  19-25 mm (3/4" to 31/32")

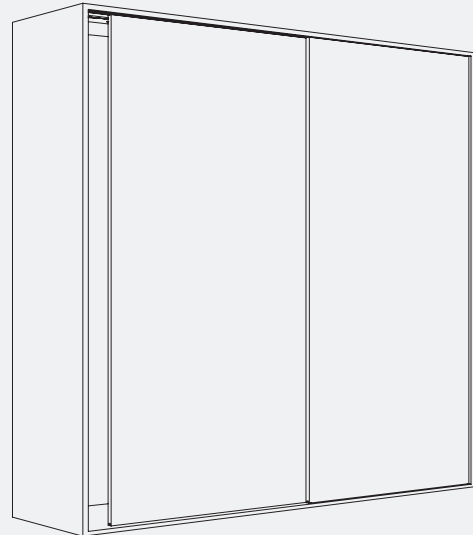



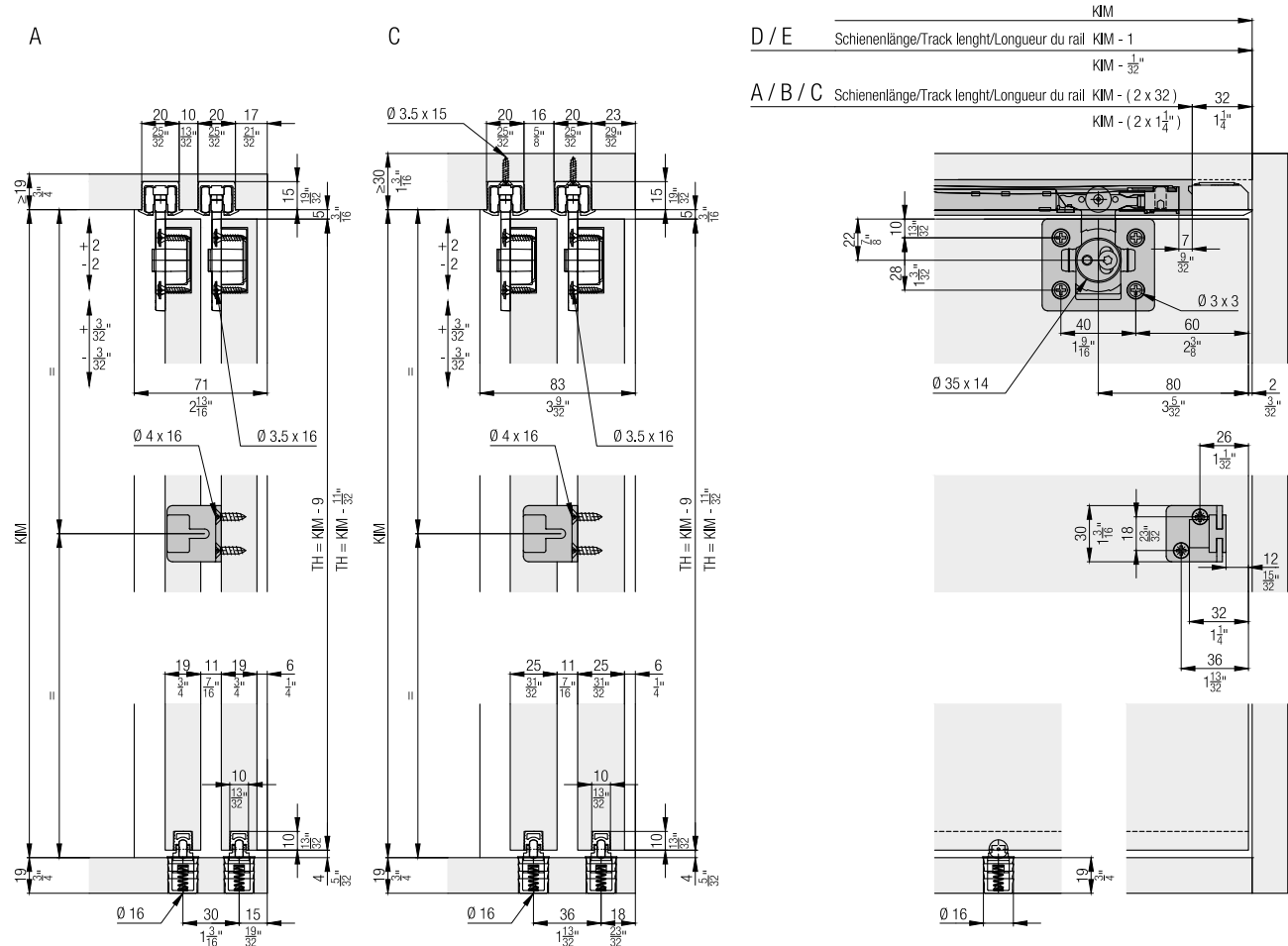

Installation examples





**Set for 2 wooden doors up to 26 kg (57 lbs.),
with height adjustment**

	No.
Hawa Clipo 26 H IS, for 2 doors	053.3353.071

Set consisting of:

		053.3353.071	No.
	Running gear, left	2	053.3349.071
	Running gear, right	2	053.3348.071
	Stopper, plastic, gray	4	057.3148.071
	Housing, plastic	4	053.0332.001
	Fillister head screw, 3.5x16 mm (5/32"x5/8"), steel, zinc-plated	16	766.6052.100
	Follower Hawa Combino/ Hawa Clipo, plastic	1	055.3123.071
	Adapter to follower steel, zinc-plated	1	055.0213.101
	Flat countersunk head chipboard screw 4x16 mm (5/32"x5/8"), steel, zinc-plated	2	600.0000.253
	Bottom guide, plastic, gray	2	055.3081.071

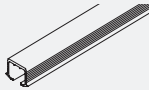
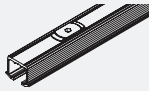
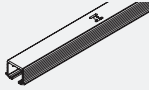
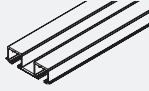

Running tracks

		mm (inch)	No.
	A: Single running track, for glue fixing, aluminum, anodized	2,500 (8' 2 7/16")	053.3324.250
		3,500 (11' 5 25/32")	053.3324.350
		6,000 (19' 8 7/32")	053.3324.600
	B: Single running track, swivel lug, aluminum, anodized (not for hard wood/ MDF)	2,500 (8' 2 7/16")	053.3327.250
		3,500 (11' 5 25/32")	053.3327.350
		6,000 (19' 8 7/32")	053.3327.600
	C: Single running track, for screw fixing, aluminum, anodized	2,500 (8' 2 7/16")	053.3325.250
		3,500 (11' 5 25/32")	053.3325.350
		6,000 (19' 8 7/32")	053.3325.600
	D: Double running track, for screw fixing, aluminum, anodized, for door thickness of 25 mm (31/32")	2,500 (8' 2 7/16")	053.3328.250
		3,500 (11' 5 25/32")	053.3328.350
		6,000 (19' 8 7/32")	053.3328.600
	E: Double running track, for screw fixing, aluminum, anodized, for door thickness of 19 mm (3/4")	2,500 (8' 2 7/16")	053.3339.250
		3,500 (11' 5 25/32")	053.3339.350
		6,000 (19' 8 7/32")	053.3339.600

Track end piece set for single running tracks

	No.
Track-end section, for screw fixing, plastic, gray, 2-piece set	053.3354.071
Track-end section, swivel lug, plastic, gray, 2-piece set	053.3355.051

Set consisting of:

	053.3354.071	053.3355.051	No.
 Track-end piece, for screw fixing, plastic	2		053.0334.001
 Chipboard screw, 4x12 mm (5/32"x15/32"), steel, zinc-plated	2		600.0000.704
 Track-end piece, with swivel lug, plastic		2	053.3351.071

Guide tracks

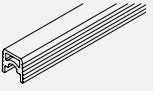
	mm (inch)	No.
	2,500 (8' 2 7/16")	055.3171.250
	3,500 (11' 5 25/32")	055.3171.350
	6,000 (19' 8 7/32")	055.3171.600

Panels

	mm (inch)	No.
	2,500 (8' 2 7/16")	053.5050.250
	3,500 (11' 5 25/32")	053.5050.350
	6,000 (19' 8 7/32")	053.5050.600

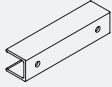

Clip-on components

	No.
 Clip component for wooden panel, for 053.3339, every 700–800 mm (2' 3 9/16" to 2' 7 15/32"), aluminum, pre-drilled	053.5051.001

Soft close up to 15/26 kg (33/57 lbs.)

	No.
Soft close, up to 15 kg (33 lbs.)	057.3159.071
Soft close, up to 26 kg (57 lbs.)	057.3159.072

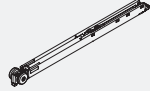
Set consisting of:

	057.3159.071	057.3159.072	No.
 Soft close, up to 15 kg (33 lbs.)	2		057.3156.071
 Release piece soft close	2	2	057.0182.101
 Thread rolling rounded head screw, M2.5x5 mm (3/32"x3/16"), steel, zinc-plated	2	2	600.0000.764
 Soft close, up to 26 kg (57 lbs.)		2	057.3156.072

Guide tracks 4-point guidance

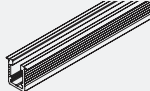

	mm (inch)	No.
 Single guide track, for glue fixing, aluminum, anodized	6,000 (19' 8 7/32")	053.3296.600

Components 4-point guidance

	No.
 Bottom guide Hawa Clipo IS/Hawa Regal C 16, plastic, anthracite	040.3124.071
 Stopper guide track, plastic, grey	053.5094.071

Door centering

	No.
Door centering, plastic, anthracite, for 2 doors	053.3207.071

Set consisting of:		053.3207.071	No.
	Housing door centering, plastic, anthracite	2	053.5014.001
	Pin door centering, plastic, anthracite	2	053.0171.001
	Rubber buffer, plastic, grey	1	025.0107.001

Accessories

	No.	
	Track cleaner, plastic, red	040.3142.071

Further installation examples

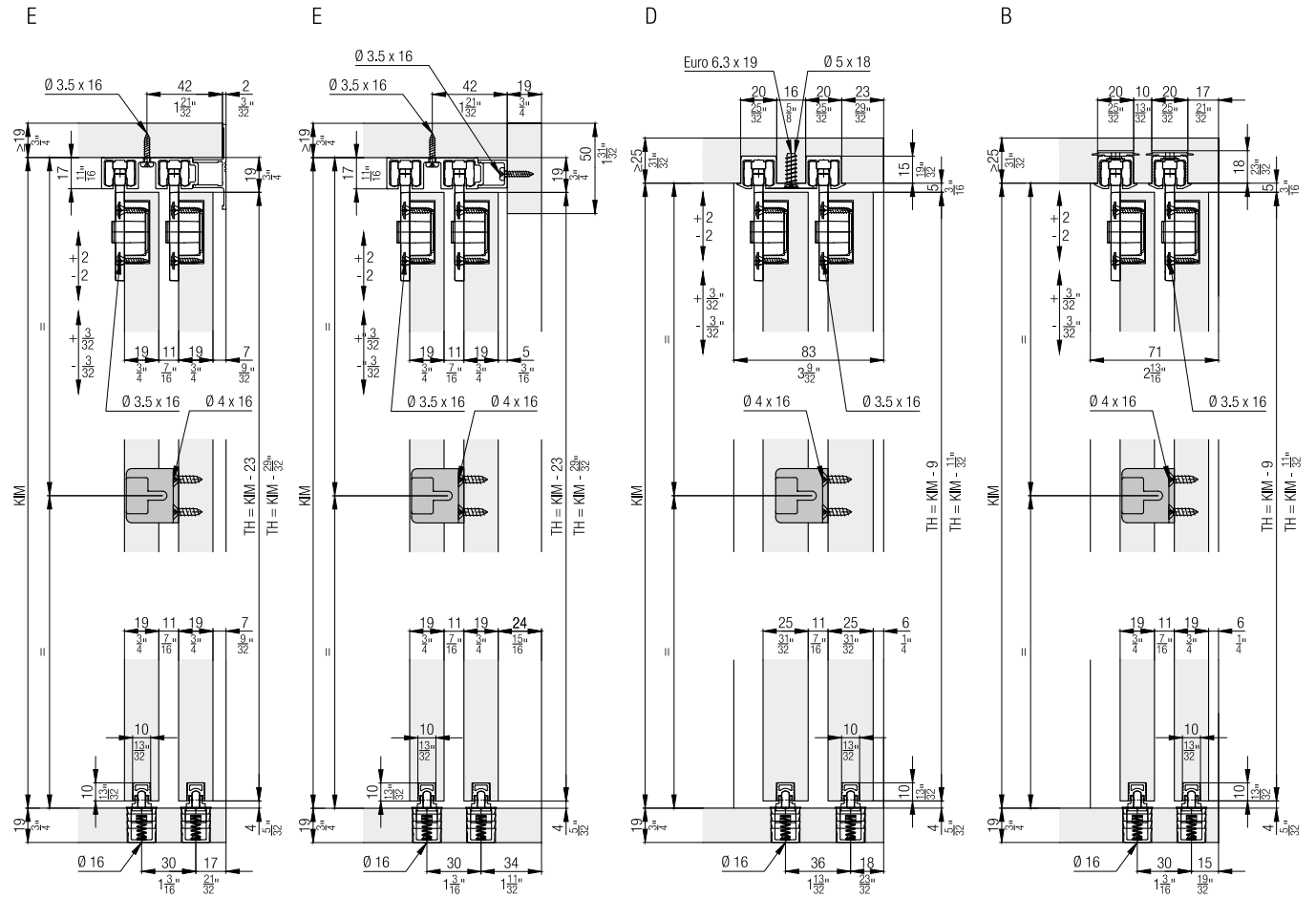

Calculations

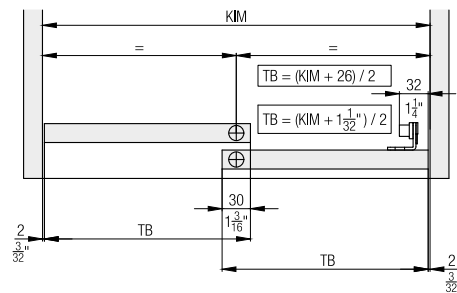

4 point guidance

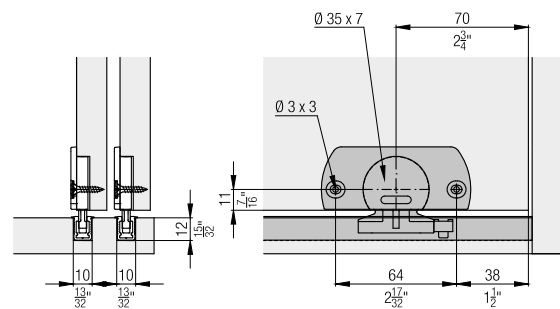

Door centering

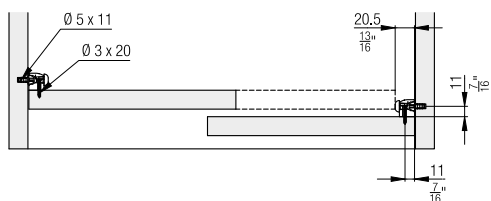

Soft close

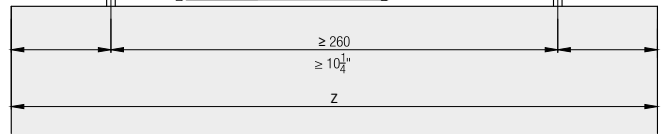

	Z ≥	
	1	2
Hawa Porta 40 H	1' 4 17/32"	2' 0 13/32"
Hawa Porta 40 GE	1' 2 13/16"	1' 10 11/16"
Hawa Clipo 26 H IS	1' 4 17/32"	2' 0 13/32"
Hawa Clipo 26 H MS	1' 6 1/32"	2' 1 29/32"
Hawa Clipo 36 H IS	1' 4 17/32"	2' 0 13/32"
Hawa Clipo 36 H MS	1' 6 3/32"	2' 1 29/32"
Hawa Clipo 36 HM IS	1' 4 17/32"	2' 0 13/32"
Hawa Clipo 26 GR IS	1' 4 17/32"	2' 0 13/32"
Hawa Clipo 36 G IS	1' 4 17/32"	2' 0 13/32"
Hawa Clipo 36 GPK IS	1' 4 17/32"	2' 0 13/32"
Hawa Clipo 36 GPPK IS	1' 4 17/32"	2' 0 13/32"
Hawa Regal C 26 HM IS	1' 4 17/32"	2' 0 13/32"
Hawa Regal C 26 GR IS	1' 3 3/4"	1' 11 5/8"

	Z ≥	
	1	2
Hawa Porta 40 H	420	620
Hawa Porta 40 GE	376	576
Hawa Clipo 26 H IS	420	620
Hawa Clipo 26 H MS	458	658
Hawa Clipo 36 H IS	420	620
Hawa Clipo 36 H MS	458	658
Hawa Clipo 36 HM IS	420	620
Hawa Clipo 26 GR IS	420	620
Hawa Clipo 36 G IS	420	620
Hawa Clipo 36 GPK IS	420	620
Hawa Clipo 36 GPPK IS	420	620
Hawa Regal C 26 HM IS	420	620
Hawa Regal C 26 GR IS	400	600

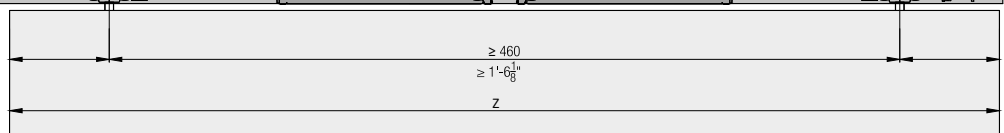

Accessories

– Straightening fitting from page 236

Planning/execution

Further information about the product can be found on www.hawa.com.